

# Excel Enbeam OM3 Fibre Optic Patch Lead Uniboot LC-LC Multimode 50/125 DX LS0H Aqua 1 m

Item Code: 203-401

**excel**  
without compromise.



✕ Available in OM3/OM4/OS2

✕ 100% Optically Tested

✕ Low Loss Connectors

✕ Very small 2mm diameter cable

✕ Easy polarity change

✕ 25 Year system warranty

## Product Overview

Excel's range of LC Uniboot patch cords provide excellent performance in a compact design, using 2 mm round cable containing 2 x 600 micron diameter fibres, which are ideal in high density applications. They are available in a choice of OM3, OM4 or OS2 bend-insensitive fibre.

These patch cords are available in two versions - standard uniboot and pull-tab version. Both versions allow for easy polarity changing.

## Product Specifications

Feature	Values
Fibre type	Multi mode 50/125
Category	OM3
Number of Cores	2
Outer diameter sheath single fibre	2 mm
Cable type	Duplex
Length	1 m
Type of connector connection 1	LC (Uniboot)
Type of connector connection 2	LC (Uniboot)
Outer sheath colour	Aqua
Strain relief boot	Push-on

Flame retardant according to IEC 60332-1-2 yes

Low smoke (acc. IEC 61034-2) yes

## Cable specifications

Features	OM3	OM4
Cable Construction	Round Duplex	Round Duplex
No. of Fibres	2	2
Cable Nominal Diameter	2.0mm	2.0mm
Colour	Aqua	Heather Violet
Strength members	Aramid Yarn	Aramid Yarn
Temperature range	-20C to +70C	-20C to +70C
Connector Material	Composite	Composite
Minimum bend radius (loaded)	10 x cable diameter	10 x cable diameter
Connector Ferrule	1.25mm Ceramic	1.25mm Ceramic
Ferrule End Face	PC Polish	PC Polish
Connector Insertion Loss	Max. 0.3dB	Max. 0.3dB

## Fibre specifications

Features	Values
Fibre Attenuation @ 850nm	Less than 3.5dB/km
Fibre Attenuation @ 1300nm	Less than 1.5dB/km
Connector IL - Typical	0.15dB
Connector IL - Max	0.3dB
Connector Return Loss	Less than -30dB

### Cross-section diagram

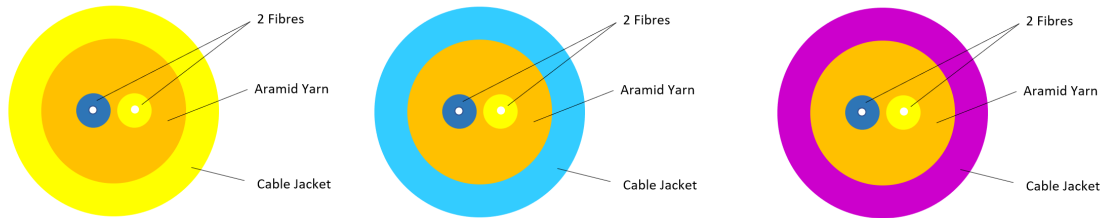

### Product drawing

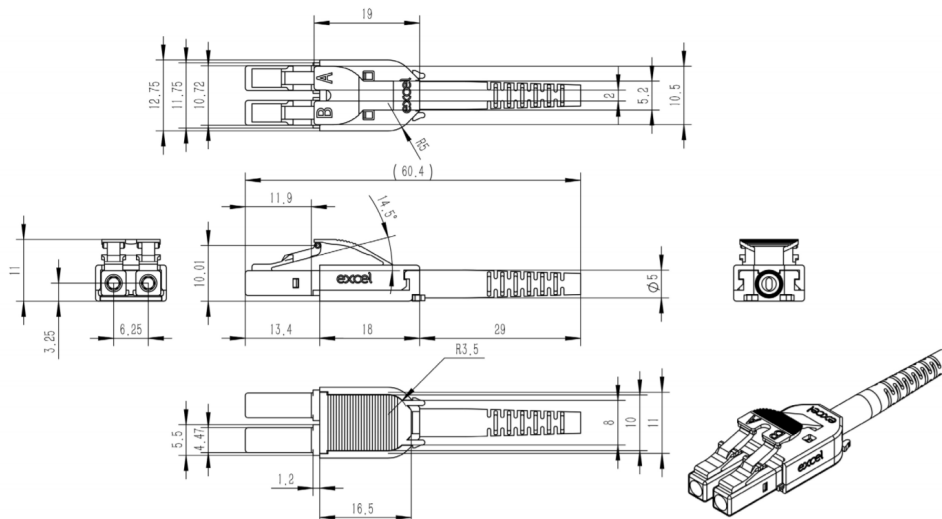

### Standards

Applicable standard	Detail
BS EN 60332-1-2:2004+A11:2016	Tests on electric and optical fibre cables under fire conditions - Test for vertical flame propagation for a single insulated wire or cable. Procedure for 1 kW pre-mixed flame
IEC 60793-1-1:2022	Optical fibres - Part 1-1: Measurement methods and test procedures - General and guidance
IEC 60793-2:2015	Optical fibres - Part 2: Product specifications - General
IEC 60793-2-10:2017	Sectional specification for A1 multimode fibres
IEC 60793-1-20:2014	Optical fibres - Part 1-20: Measurement methods and test procedures - Fibre geometry
IEC 60793-1-21:2001	Optical fibres - Part 1-21: Measurement methods and test procedures - Coating geometry

# Excel Enbeam OM3 Fibre Optic Patch Lead Uniboot LC-LC Multimode 50/125 DX LS0H Aqua 1 m

Item Code: 203-401



IEC 60793-1-22:2001	Optical fibres - Part 1-22: Measurement methods and test procedures - Length measurement
IEC 60793-1-30:2010	Optical fibres - Part 1-30: Measurement methods and test procedures - Fibre proof test
IEC 60793-1-31:2010	Optical fibres - Part 1-31: Measurement methods and test procedures - Tensile Strength
ITU G.651.1	Characteristics of a 50/125 µm multimode graded index optical fibre cable for the optical access network
EN 50173-1:2018	Information technology. Generic cabling systems - General requirements
EN 50173-2:2007 + A1:2010	Information technology. Generic cabling systems - Office premises
IEC 61754-1:2013	Fibre optic interconnecting devices and passive components - Fibre optic connector interfaces - Part 1: General and guidance
IEC 61754-2:1996	Fibre optic connector interfaces - Part 2: Type BFOC/2,5 connector family
IEC 61754-4:2013	Fibre optic interconnecting devices and passive components - Fibre optic connector interfaces - Part 4: Type SC connector family
IEC 61754-4-100:2015	Fibre optic interconnecting devices and passive components - Fibre optic connector interfaces - Part 4-100: Type SC connector family - Simplified receptacle SC-PC connector interfaces
RoHS-II/III (2011/65/EU & 2015/863): 2023	Our products, demonstrate full adherence to the regulatory stipulations of the EU Directive 2011/65/EU (RoHS-II) and its corresponding delegated directive 2015/863 (RoHS-III).
WFD: 2023	Compliant to Waste Framework Directive
SCIP: 2023	Compliant - Does Not Contain Substances of Concern In articles as such or in complex objects (Products)
POPs (EU) No 2019/1021	EU Regulation for the restriction of Persistent Organic Pollutants.

## Part Number Table

Part Number	Description
203-400	Excel Enbeam OM3 Fibre Optic Patch Lead Uniboot LC-LC Multimode 50/125 DX LS0H Aqua 0.5 m
203-401	Excel Enbeam OM3 Fibre Optic Patch Lead Uniboot LC-LC Multimode 50/125 DX LS0H Aqua 1 m

# Excel Enbeam OM3 Fibre Optic Patch Lead Uniboot LC-LC Multimode 50/125 DX LS0H Aqua 1 m

Item Code: 203-401



203-402	Excel Enbeam OM3 Fibre Optic Patch Lead Uniboot LC-LC Multimode 50/125 DX LS0H Aqua 2 m
203-403	Excel Enbeam OM3 Fibre Optic Patch Lead Uniboot LC-LC Multimode 50/125 DX LS0H Aqua 3 m
203-405	Excel Enbeam OM3 Fibre Optic Patch Lead Uniboot LC-LC Multimode 50/125 DX LS0H Aqua 5 m
203-410	Excel Enbeam OM3 Fibre Optic Patch Lead Uniboot LC-LC Multimode 50/125 DX LS0H Aqua 10 m
203-415	Excel Enbeam OM3 Fibre Optic Patch Lead Uniboot LC-LC Multimode 50/125 DX LS0H Aqua 15 m
203-420	Excel Enbeam OM3 Fibre Optic Patch Lead Uniboot LC-LC Multimode 50/125 DX LS0H Aqua 20 m
204-400	Excel Enbeam OM4 Fibre Optic Patch Lead Uniboot LC-LC Multimode 50/125 DX LS0H Violet 0.5 m
204-401	Excel Enbeam OM4 Fibre Optic Patch Lead Uniboot LC-LC Multimode 50/125 DX LS0H Violet 1 m
204-402	Excel Enbeam OM4 Fibre Optic Patch Lead Uniboot LC-LC Multimode 50/125 DX LS0H Violet 2 m
204-403	Excel Enbeam OM4 Fibre Optic Patch Lead Uniboot LC-LC Multimode 50/125 DX LS0H Violet 3 m
204-405	Excel Enbeam OM4 Fibre Optic Patch Lead Uniboot LC-LC Multimode 50/125 DX LS0H Violet 5 m
204-410	Excel Enbeam OM4 Fibre Optic Patch Lead Uniboot LC-LC Multimode 50/125 DX LS0H Violet 10 m
204-415	Excel Enbeam OM4 Fibre Optic Patch Lead Uniboot LC-LC Multimode 50/125 DX LS0H Violet 15 m
204-420	Excel Enbeam OM4 Fibre Optic Patch Lead Uniboot LC-LC Multimode 50/125 DX LS0H Violet 20 m

Excel is a world class premium performing end to end infrastructure solution designed, Manufactured, supported and delivered without compromise.

Contact us at [sales@excel-networking.com](mailto:sales@excel-networking.com)



E&OE. Excel is a registered trade name of Mayflex Holdings Ltd.