

Excel 4 Way GOP Box Plus 25 mm (10-Pack)

Part Code: 350-640

sales@excel-networking.com
excel-networking.com

CIBSE TM65 Embodied Carbon: 20.438 kg CO2e



Main Features

- / 4-Way
- / 25 mm 'L' Brackets available
- / Accepts Category 5e, Category 6 or Category 6A
- / 25 mm knockout for conduit
- / 6c aperture size
- / 25 Year system warranty

Product Overview

The Excel Grid Outlet Position (GOP) Box Plus has been developed from the successful original versions. This range is available in four versions from 2 Way to 12 Way. The 2 and 4 way are available with a 25 mm flexible conduit fixing point. The 4 and 6 way are available with a 32 mm flexible conduit fixing point. The range has been developed for fixing to the end of flexible conduit typically where outlets are presented in a grid layout with cable containment mounted within a raised floor system. The GOP Box then has a degree of flexibility to be positioned within the radius of the flexible conduit to suit the office layout. 25 mm and 32 mm "L" Brackets are available to fix the other end of the flexible conduit to the floor slab. GOP Boxes are typically then attached to the underside of the desk, the flexible...

Excel 4 Way GOP Box Plus 25 mm (10-Pack)

Part Code: 350-640

sales@excel-networking.com
excel-networking.com

Product Specifications

Feature	Values
Surface mounted	yes
Floor box/sub-floor mounted	yes
Type of fastening	Screwing
With outlets/modules	no
Suitable for number of outlets/modules	4
With label space	no

Excel 4 Way GOP Box Plus 25 mm (10-Pack)

Part Code: 350-640

sales@excel-networking.com
excel-networking.com

Product drawing (2-6 way versions)

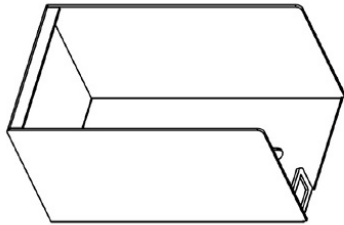
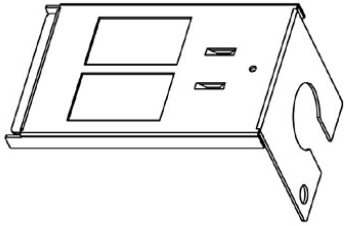

2 Way GOP Box Plus

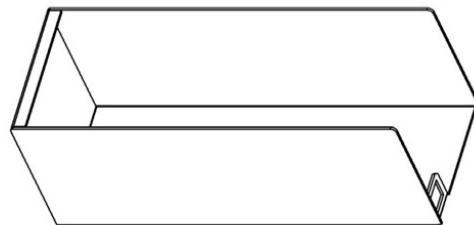
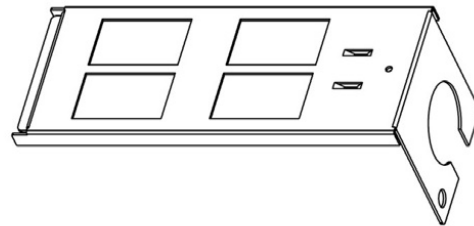

4 Way GOP Box Plus

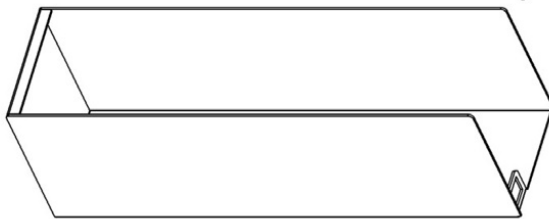

6 Way GOP Box Plus

Excel 4 Way GOP Box Plus 25 mm (10-Pack)

Part Code: 350-640

sales@excel-networking.com
excel-networking.com

Product drawing (4 way version)

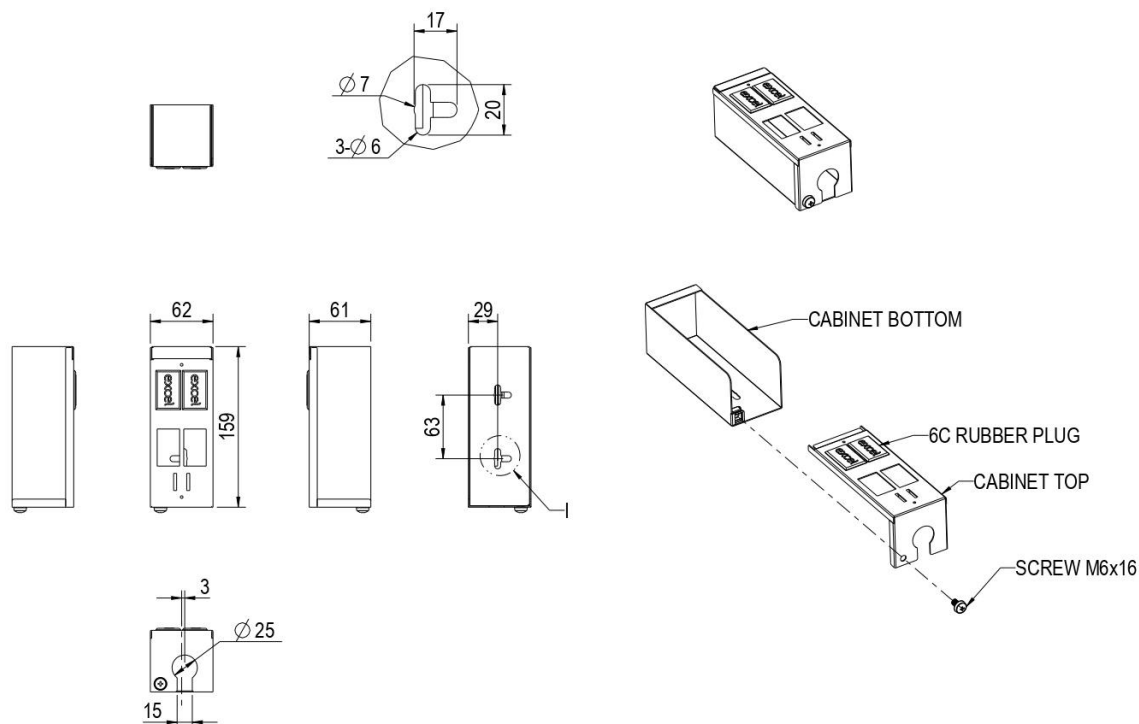

Standards

Applicable standard	Detail
Directive 2011/65/EU (RoHS II)	Restriction of the Use of Certain Hazardous Substances in Electrical and Electronic Equipment — compliant. Applies within EU member states).
Directive (EU) 2015/863 (RoHS III)	Amending Directive 2011/65/EU to add four phthalates (DEHP, BBP, DBP, DIBP) to Annex II — compliant.
Directive 2008/98/EC (WFD)	Waste Framework Directive — compliant. Implemented in the UK through the Waste (England and Wales) Regulations 2011 (SI 2011 No. 988).
ECHA SCIP Database	Compliant; product does not contain SVHCs (Substances of Very High Concern) as defined under REACH Article 33(1). Submission obligations met under EU REACH and UK REACH.

Excel 4 Way GOP Box Plus 25 mm (10-Pack)

Part Code: 350-640

sales@excel-networking.com
excel-networking.com

Regulation (EU) 2019/1021 (POPs)

EU Regulation on Persistent Organic Pollutants — compliant. For Great Britain, compliance is aligned with the Persistent Organic Pollutants (Amendment) (EU Exit) Regulations 2020 (SI 2020 No. 1355).

UK SI 2012 No. 3032

The Restriction of the Use of Certain Hazardous Substances in Electrical and Electronic Equipment Regulations 2012 (UK RoHS) — compliant for Great Britain. Retained EU law, as amended by the Product Safety and Metrology (Amendment etc.) (EU Exit) Regulations 2019.

Part Code Table

Part Code	Description
350-640	Excel 4 Way GOP Box Plus 25 mm (10-Pack)