

# Environ CR800 29U Rack 800x600mm Glass (F) Steel (R) B/Panels F/Mgmt Grey White

Item Code: 542-2986-GSBF-GW

**excel**  
without compromise.



✕ Choice of doors/depths/colours available

✕ 19" profiles marked with U height position

✕ Large cut out in base for cable entry

✕ Brush strip cable entry in roof and base of rack

✕ IP20 when fitted with base plate

✕ Racks supplied assembled or flat packed

✕ High density vertical cable management

## Product Overview

Environ CR800 Comms Racks are a versatile range of 800mm wide racks with features suitable for a wide range of applications within the data, security, audio visual and telecommunications markets.

## Product Specifications

Feature	Values
Mounting Profile	Front and rear
Type of profile rail	L-shaped
Number of doors	2
Type of ventilation	Passive
Width	800 mm
Height	1490 mm
Depth	600 mm
Modular spacing	19 inch
Number of rack units (RU)	29
Max. load capacity	800 kg

# Environ CR800 29U Rack 800x600mm Glass (F) Steel (R) B/Panels F/Mgmt Grey White

Item Code: 542-2986-GSBF-GW



With roof plate	yes
With earthing	yes
With front door	yes
Front door material	Glass
Front door locking system	One point
With rear door	yes
Rear door material	Steel
Rear door locking system	One point
Side panels included	yes
With vertical cable management	yes
Material	Steel
Type of surface	Powder coated
Colour	Grey
RAL-number	9002
Flat-packed	no
IP-rating	IP20

## Additional specifications

Features	Values
Material	SPCC Cold Rolled Steel
19" Rails	2.0 mm thick
Side Panels	1.0 mm thick
Other	1.2 mm thick
Front door	Swing handle cam lock
Rear door	Barrel lock
Side panels lock	Single point barrel lock
Jacking feet additional height	50-80 mm
Castors additional height	70 mm

# Environ CR800 29U Rack 800x600mm Glass (F) Steel (R) B/Panels F/Mgmt Grey White

Item Code: 542-2986-GSBF-GW



## Standards

Standard	Detail
ANSI/EIA-310-E	Electronic Industries Association standard for horizontal spacing, vertical hole spacing, rack opening and front panel width
BS EN 60297-3-100:2009	Mechanical structures for electronic equipment. Dimensions of mechanical structures of the 482,6 mm (19 in) series. Basic dimensions of front panels, subracks, chassis, racks and cabinets
DIN 41494 Part 1 & 7	Panel Mounting Racks For Electronics Equipments; Racks And Panels, Dimensions; Dimensions of cabinets and suites of racks
RoHS-II/III (2011/65/EU & 2015/863): 2023	Our products, demonstrate full adherence to the regulatory stipulations of the EU Directive 2011/65/EU (RoHS-II) and its corresponding delegated directive 2015/863 (RoHS-III).
WFD: 2023	Compliant to Waste Framework Directive
SCIP: 2023	Compliant - Does Not Contain Substances of Concern In articles as such or in complex objects (Products)
POPs (EU) No 2019/1021	EU Regulation for the restriction of Persistent Organic Pollutants.

Environ CR800 29U Rack 800x600mm Glass (F)  
Steel (R) B/Panels F/Mgmt Grey White

Item Code: 542-2986-GSBF-GW

**excel**  
without compromise.

### Product images



Four-way brush entry roof panel



Quick-slam latch side panels



Swing handle glass front door



Steel rear door

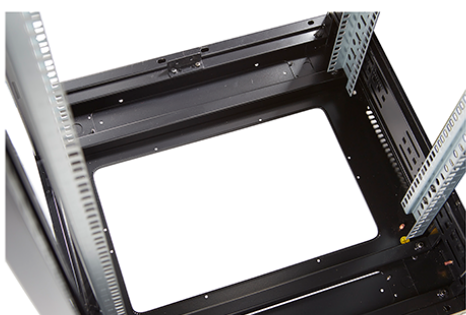

Large base entry

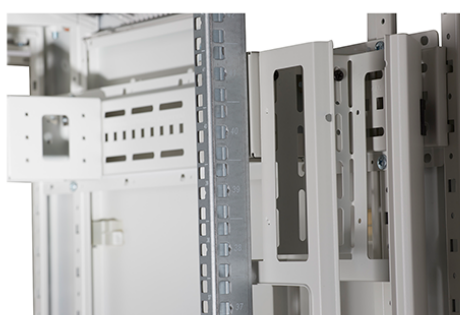

High-density vertical cable management

Environ CR800 29U Rack 800x600mm Glass (F)  
Steel (R) B/Panels F/Mgmt Grey White

Item Code: 542-2986-GSBF-GW

**excel**  
without compromise.

### Product drawings

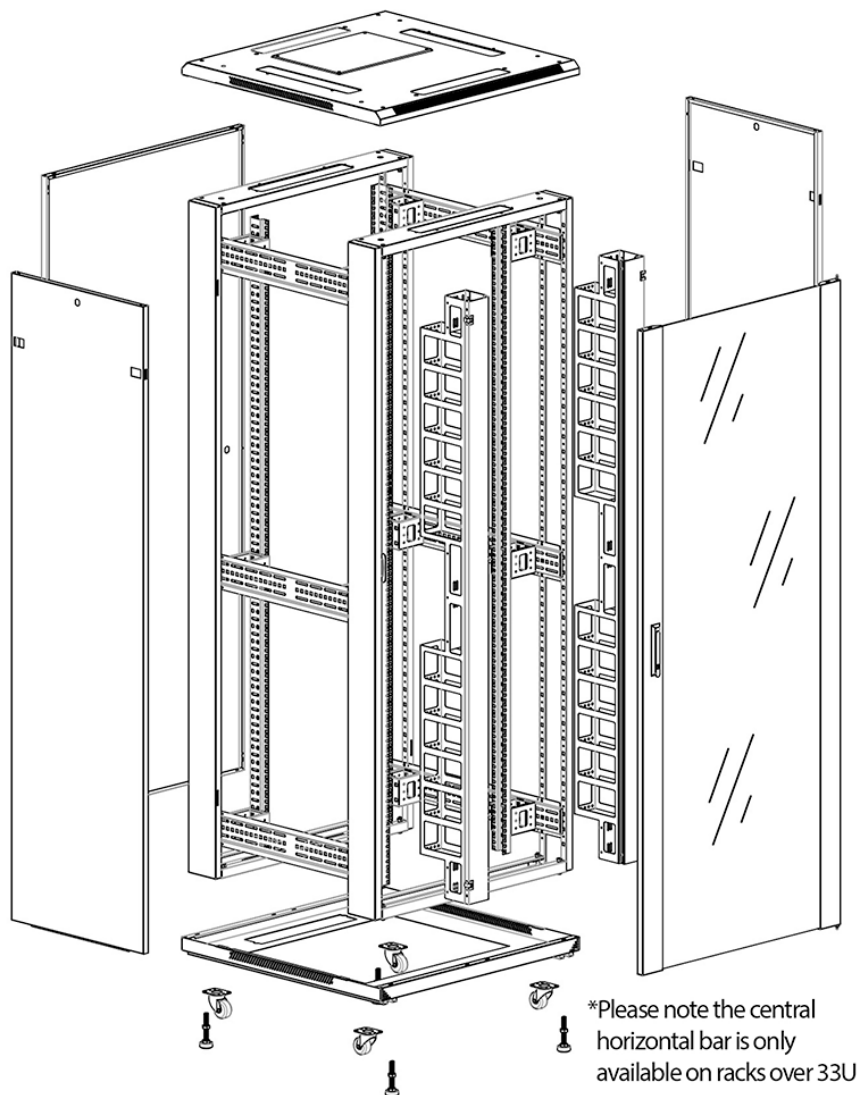

Environ CR800 29U Rack 800x600mm Glass (F)  
Steel (R) B/Panels F/Mgmt Grey White

Item Code: 542-2986-GSBF-GW



Product drawings

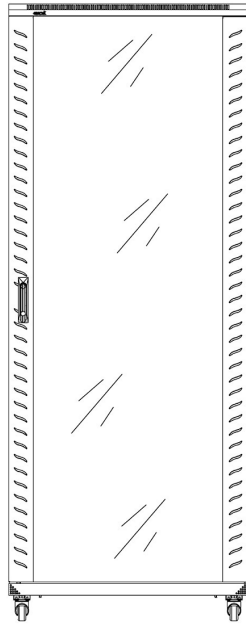

Front

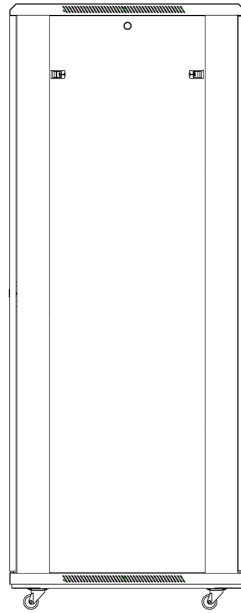

Side

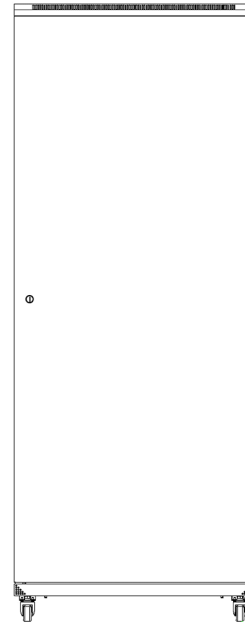

Rear

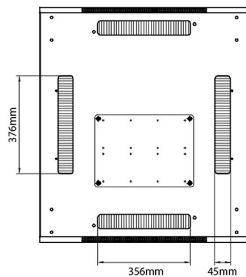

Roof

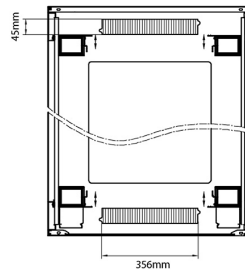

Base

Base Cut Out Dimensions

580 mm Wide  
by  
276 mm Deep (600 mm deep rack)  
476 mm Deep (800 mm deep rack)  
676 mm Deep (1000 mm deep rack)

Part Number Table

Part Number	Description
542-1588-GSBF-BK	Environ CR600 15U Rack 800x800 mm Glass (F) Steel (R) B/Panels Fr/Mgmt Black
542-2088-GSBF-BK	Environ CR800 20U Rack 800x800 mm Glass (F) Steel (R) B/Panels Fr/Mgmt Black

# Environ CR800 29U Rack 800x600mm Glass (F) Steel (R) B/Panels F/Mgmt Grey White

Item Code: 542-2986-GSBF-GW



542-24810-GSBF-BK	Environ CR800 24U Rack 800x1000 mm Glass (F) Steel (R) B/Panels Fr/Mgmt Black
542-2486-GSBF-BK	Environ CR800 24U Rack 800x600mm Glass (F) Steel (R) B/Panels F/Mgmt Black
542-2486-GSBF-BK-FP	Environ CR800 24U Rack 800x600mm Glass (F) Steel (R) B/Panels F/Mgmt Black Flat Pack
542-2486-GSBF-GW	Environ CR800 24U Rack 800x600mm Glass (F) Steel (R) B/Panels F/Mgmt Grey White
542-2486-GSBF-GW-FP	Environ CR800 24U Rack 800x600mm Glass (F) Steel (R) B/Panels F/Mgmt Grey White Flat Pack
542-2488-GSBF-BK	Environ CR800 24U Rack 800x800mm Glass (F) Steel (R) B/Panels F/Mgmt Black
542-2488-GSBF-BK-FP	Environ CR800 24U Rack 800x800mm Glass (F) Steel (R) B/Panels F/Mgmt Black Flat Pack
542-2488-GSBF-GW	Environ CR800 24U Rack 800x800mm Glass (F) Steel (R) B/Panels F/Mgmt Grey White
542-2488-GSBF-GW-FP	Environ CR800 24U Rack 800x800mm Glass (F) Steel (R) B/Panels F/Mgmt Grey White Flat Pack
542-29810-GSBF-BK	Environ CR800 29U Rack 800x1000mm Glass (F) Steel (R) B/Panels F/Mgmt Black
542-29810-GSBF-BK-FP	Environ CR800 29U Rack 800x1000mm Glass (F) Steel (R) B/Panels F/Mgmt Black Flat Pack
542-29810-GSBF-GW	Environ CR800 29U Rack 800x1000mm Glass (F) Steel (R) B/Panels F/Mgmt Grey White
542-29810-GSBF-GW-FP	Environ CR800 29U Rack 800x1000mm Glass (F) Steel (R) B/Panels F/Mgmt Grey White Flat Pack
542-2986-GSBF-BK	Environ CR800 29U Rack 800x600mm Glass (F) Steel (R) B/Panels F/Mgmt Black
542-2986-GSBF-BK-FP	Environ CR800 29U Rack 800x600mm Glass (F) Steel (R) B/Panels F/Mgmt Black Flat Pack
542-2986-GSBF-GW	Environ CR800 29U Rack 800x600mm Glass (F) Steel (R) B/Panels F/Mgmt Grey White
542-2986-GSBF-GW-FP	Environ CR800 29U Rack 800x600mm Glass (F) Steel (R) B/Panels F/Mgmt Grey White Flat Pack
542-2988-GSBF-BK	Environ CR800 29U Rack 800x800mm Glass (F) Steel (R) B/Panels F/Mgmt Black
542-2988-GSBF-BK-FP	Environ CR800 29U Rack 800x800mm Glass (F) Steel (R) B/Panels F/Mgmt Black Flat Pack
542-2988-GSBF-GW	Environ CR800 29U Rack 800x800mm Glass (F) Steel (R) B/Panels F/Mgmt Grey White

# Environ CR800 29U Rack 800x600mm Glass (F) Steel (R) B/Panels F/Mgmt Grey White

Item Code: 542-2986-GSBF-GW



542-2988-GSBF-GW-FP	Environ CR800 29U Rack 800x800mm Glass (F) Steel (R) B/Panels F/Mgmt Grey White Flat Pack
542-33810-GSBF-BK	Environ CR800 33U Rack 800x1000mm Glass (F) Steel (R) B/Panels F/Mgmt Black
542-33810-GSBF-BK-FP	Environ CR800 33U Rack 800x1000mm Glass (F) Steel (R) B/Panels F/Mgmt Black Flat Pack
542-33810-GSBF-GW	Environ CR800 33U Rack 800x1000mm Glass (F) Steel (R) B/Panels F/Mgmt Grey White
542-33810-GSBF-GW-FP	Environ CR800 33U Rack 800x1000mm Glass (F) Steel (R) B/Panels F/Mgmt Grey White Flat Pack
542-3386-GSBF-BK	Environ CR800 33U Rack 800x600mm Glass (F) Steel (R) B/Panels F/Mgmt Black
542-3386-GSBF-BK-FP	Environ CR800 33U Rack 800x600mm Glass (F) Steel (R) B/Panels F/Mgmt Black Flat Pack
542-3386-GSBF-GW	Environ CR800 33U Rack 800x600mm Glass (F) Steel (R) B/Panels F/Mgmt Grey White
542-3386-GSBF-GW-FP	Environ CR800 33U Rack 800x600mm Glass (F) Steel (R) B/Panels F/Mgmt Grey White Flat Pack
542-3388-GSBF-BK	Environ CR800 33U Rack 800x800mm Glass (F) Steel (R) B/Panels F/Mgmt Black
542-3388-GSBF-BK-FP	Environ CR800 33U Rack 800x800mm Glass (F) Steel (R) B/Panels F/Mgmt Black Flat Pack
542-3388-GSBF-GW	Environ CR800 33U Rack 800x800mm Glass (F) Steel (R) B/Panels F/Mgmt Grey White
542-3388-GSBF-GW-FP	Environ CR800 33U Rack 800x800mm Glass (F) Steel (R) B/Panels F/Mgmt Grey White Flat Pack
542-42810-GSBF-BK	Environ CR800 42U Rack 800x1000mm Glass (F) Steel (R) B/Panels F/Mgmt Black
542-42810-GSBF-BK-FP	Environ CR800 42U Rack 800x1000mm Glass (F) Steel (R) B/Panels F/Mgmt Black Flat Pack
542-42810-GSBF-GW	Environ CR800 42U Rack 800x1000mm Glass (F) Steel (R) B/Panels F/Mgmt Grey White
542-42810-GSBF-GW-FP	Environ CR800 42U Rack 800x1000mm Glass (F) Steel (R) B/Panels F/Mgmt Grey White Flat Pack
542-4286-GSBF-BK	Environ CR800 42U Rack 800x600mm Glass (F) Steel (R) B/Panels F/Mgmt Black
542-4286-GSBF-BK-FP	Environ CR800 42U Rack 800x600mm Glass (F) Steel (R) B/Panels F/Mgmt Black Flat Pack
542-4286-GSBF-GW	Environ CR800 42U Rack 800x600mm Glass (F) Steel (R) B/Panels F/Mgmt Grey White
542-4286-GSBF-GW-FP	Environ CR800 42U Rack 800x600mm Glass (F) Steel (R) B/Panels F/Mgmt



# Environ CR800 29U Rack 800x600mm Glass (F) Steel (R) B/Panels F/Mgmt Grey White

Item Code: 542-2986-GSBF-GW



Grey White Flat Pack

542-4288-GSBF-BK	Environ CR800 42U Rack 800x800mm Glass (F) Steel (R) B/Panels F/Mgmt Black
542-4288-GSBF-BK-FP	Excel Environ CR800 42U Rack 800x800mm Glass (F) Steel (R) B/Panels F/Mgmt Black Flat Pack
542-4288-GSBF-GW	Environ CR800 42U Rack 800x800mm Glass (F) Steel (R) B/Panels F/Mgmt Grey White
542-4288-GSBF-GW-FP	Environ CR800 42U Rack 800x800mm Glass (F) Steel (R) B/Panels F/Mgmt Grey White Flat Pack
542-47810-GSBF-BK	Environ CR800 47U Rack 800x1000mm Glass (F) Steel (R) B/Panels F/Mgmt Black
542-47810-GSBF-BK-FP	Environ CR800 47U Rack 800x1000mm Glass (F) Steel (R) B/Panels F/Mgmt Black Flat Pack
542-47810-GSBF-GW	Environ CR800 47U Rack 800x1000mm Glass (F) Steel (R) B/Panels F/Mgmt Grey White
542-47810-GSBF-GW-FP	Environ CR800 47U Rack 800x1000mm Glass (F) Steel (R) B/Panels F/Mgmt Grey White Flat Pack
542-4786-GSBF-BK	Environ CR800 47U Rack 800x600mm Glass (F) Steel (R) B/Panels F/Mgmt Black
542-4786-GSBF-BK-FP	Environ CR800 47U Rack 800x600mm Glass (F) Steel (R) B/Panels F/Mgmt Black Flat Pack
542-4786-GSBF-GW	Environ CR800 47U Rack 800x600mm Glass (F) Steel (R) B/Panels F/Mgmt Grey White
542-4786-GSBF-GW-FP	Environ CR800 47U Rack 800x600mm Glass (F) Steel (R) B/Panels F/Mgmt Grey White Flat Pack
542-4788-GSBF-BK	Environ CR800 47U Rack 800x800mm Glass (F) Steel (R) B/Panels F/Mgmt Black
542-4788-GSBF-BK-FP	Environ CR800 47U Rack 800x800mm Glass (F) Steel (R) B/Panels F/Mgmt Black Flat Pack
542-4788-GSBF-GW	Environ CR800 47U Rack 800x800mm Glass (F) Steel (R) B/Panels F/Mgmt Grey White
542-4788-GSBF-GW-FP	Environ CR800 47U Rack 800x800mm Glass (F) Steel (R) B/Panels F/Mgmt Grey White Flat Pack

Excel is a world class premium performing end to end infrastructure solution designed, Manufactured, supported and delivered without compromise.

Contact us at [sales@excel-networking.com](mailto:sales@excel-networking.com)



E&OE. Excel is a registered trade name of Mayflex Holdings Ltd.