

Excel Plinth 800 mm Wide x 1200 mm Deep for SR Racks Black

Item Code: 544-982-BK

excel
without compromise.



Cable entry via blank plates on all sides

Cable entry knockouts x 4

Load Bearing

Takes both Levelling Feet and Castors

25 years System Warranty

CIBSE TM65 Embodied Carbon: 36.310 kg CO2e

Product Overview

Available as an option to suit all sizes of Excel Environ Racks, the plinth increases the overall height by approximately 100mm and allows for easy cable access into the base.

The plinth is manufactured with removable sides to further aid access for cabling and levelling purposes.

Product Specifications

Feature	Values
Model	Complete base kit
Material	Steel
Colour	Black
Suitable for cable patch	yes
Width	800 mm
Height	100 mm
Depth	1200 mm

Excel Plinth 800 mm Wide x 1200 mm Deep for SR Racks Black

Item Code: 544-982-BK

excel
without compromise.

Product drawing

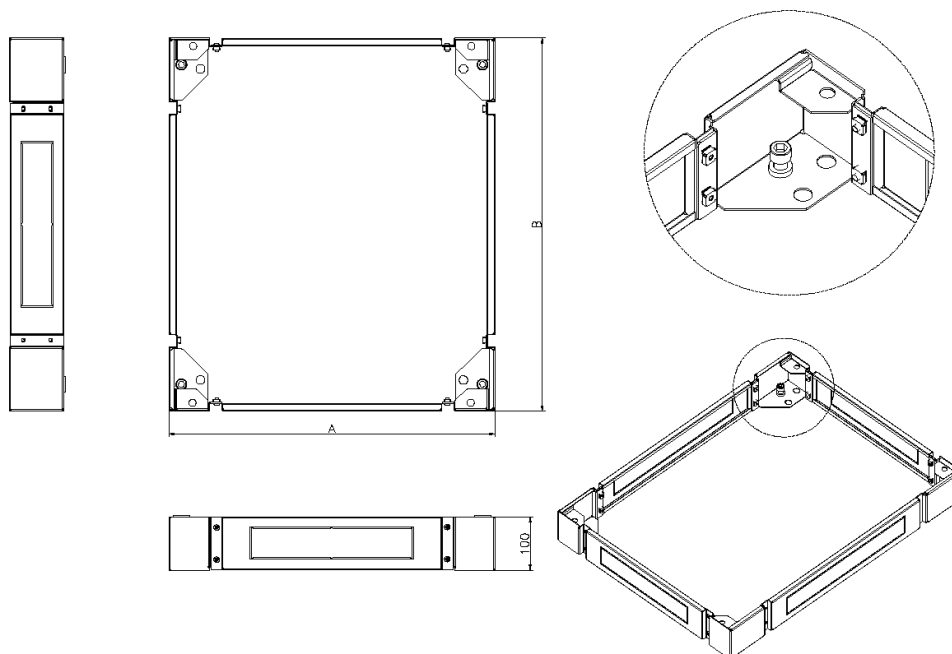

Standards

Applicable standard	Detail
Directive 2011/65/EU (RoHS II)	Restriction of the Use of Certain Hazardous Substances in Electrical and Electronic Equipment — compliant. Applies within EU member states).
Directive (EU) 2015/863 (RoHS III)	Amending Directive 2011/65/EU to add four phthalates (DEHP, BBP, DBP, DIBP) to Annex II — compliant.
Directive 2008/98/EC (WFD)	Waste Framework Directive — compliant. Implemented in the UK through the Waste (England and Wales) Regulations 2011 (SI 2011 No. 988).
ECHA SCIP Database	Compliant; product does not contain SVHCs (Substances of Very High Concern) as defined under REACH Article 33(1). Submission obligations met under EU REACH and UK REACH.
Regulation (EU) 2019/1021 (POPs)	EU Regulation on Persistent Organic Pollutants — compliant. For Great Britain, compliance is aligned with the Persistent Organic Pollutants (Amendment) (EU Exit) Regulations 2020 (SI 2020 No. 1355).
UK SI 2012 No. 3032	The Restriction of the Use of Certain Hazardous Substances in Electrical and Electronic Equipment Regulations 2012 (UK RoHS) — compliant for Great

Excel Plinth 800 mm Wide x 1200 mm Deep for SR Racks Black

Item Code: 544-982-BK



Britain. Retained EU law, as amended by the Product Safety and Metrology (Amendment etc.) (EU Exit) Regulations 2019.

Part Number Table

Part Number	Description
544-960-BK	Excel Plinth 600 mm Wide x 1000 mm Deep for SR Racks Black
544-962-BK	Excel Plinth 600 mm Wide x 1200 mm Deep for SR Racks Black
544-966-BK	Excel Plinth 600 mm Wide x 600 mm Deep for SR Racks Black
544-968-BK	Excel Plinth 600 mm Wide x 800 mm Deep for SR Racks Black
544-980-BK	Excel Plinth 800 mm Wide x 1000 mm Deep for SR Racks Black
544-982-BK	Excel Plinth 800 mm Wide x 1200 mm Deep for SR Racks Black
544-982-GE	Excel Plinth 800 mm Wide x 1200 mm Deep for SR Racks Grey White

Excel is a world class premium performing end to end infrastructure solution designed, Manufactured, supported and delivered without compromise.

Contact us at sales@excel-networking.com



E&OE. Excel is a registered trade name of Mayflex Holdings Ltd.